

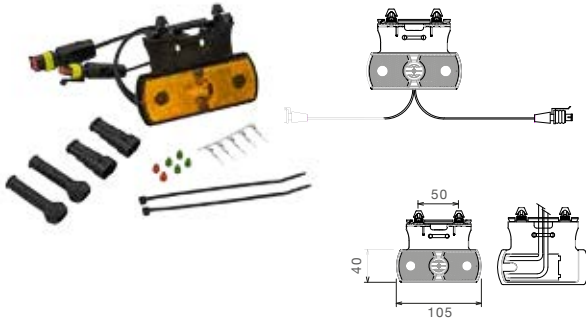

UNIPOINT II LED

ADR Zone 2 IP6K9K







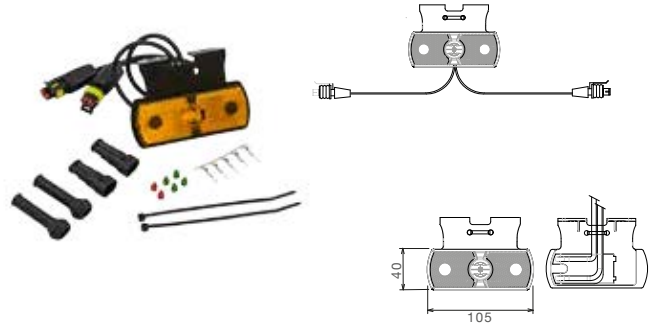



[A]



[B]



Seitenmarkierungslicht
Sidemarker light

BEST. NR				ZUSATZ	ANSCHLUSS
PART NO				ADD ON	CONNECTOR
31-2464-024	1/-	LED	24V	[A]  	2 x 2 pol. Superseal 2 x 2 pin Superseal ♀   0,40 m 
31-2464-034	1/-	LED	24V	[B]  	2 x 2 pol. Superseal 2 x 2 pin Superseal ♀   0,40 m 









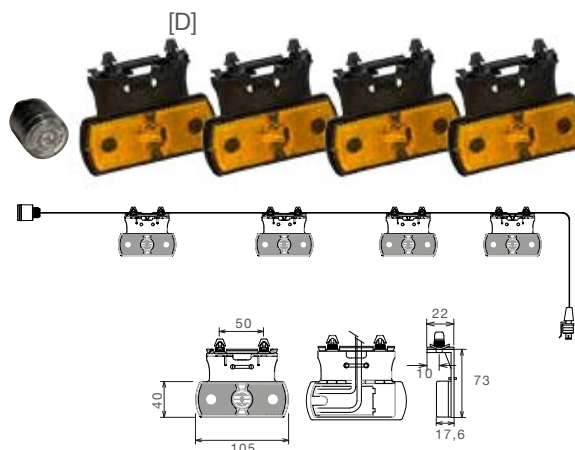
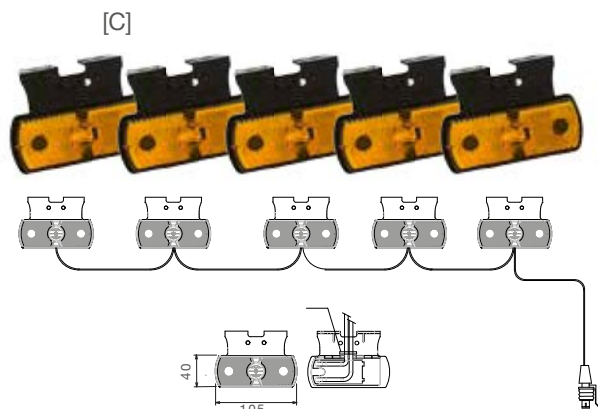







UNIPOINT II LED

ZUBEHÖHR / ACCESSORIES

ADR Zone 2 IP 6K9K



 Seitenmarkierungslicht
Sidemarker light



BEST. NR PART NO				ZUSATZ ADD ON	ANSCHLUSS CONNECTOR
87-1364-001	1/-	LED	24V	[C]  	2 pol. Superseal 2 pin Superseal   2,20 m 
87-1366-011	-/-	LED	24V	[D]  	2 pol. Superseal 2 pin Superseal   6,04 m 

Positionslampe
Position Lamp



ZUBEHÖHR / ACCESSORIES

1 Superseal Verbinder | Superseal connector

- (a) 2 pol. weiblich
2 pin female 15-7002-044 
- (b) 2 pol. männlich
2 pin male 15-7002-054 

1a



1b

