



REGPOINT II LED









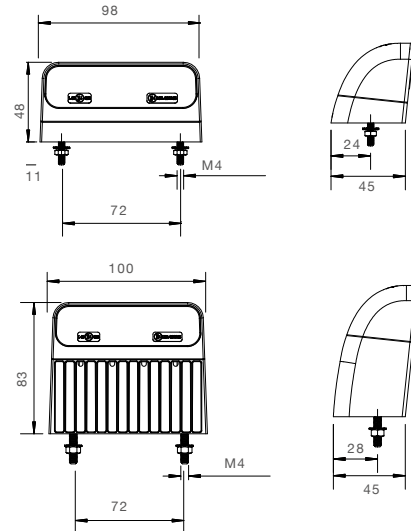































ADR Zone 2

IP 54



 Kennzeichenlicht
Number plate light



BEST. NR					ZUSATZ	ANSCHLUSS			
PART NO					ADD ON	CONNECTOR			
36-3804-004	1/-	LED	12V 24V			P&R		0,50 m	
36-3804-014	1/-	LED	12V 24V			P&R		2,00 m	
36-3806-004	1/-	LED	12V 24V			2 pol. ASS2 2 pin ASS2		0,50 m	
36-3805-004	1/-	LED	12V 24V			2 pol. ASS2 2 pin ASS2		2,00 m	
36-3807-004	1/-	LED	12V 24V			2 pol. Superseal 2 pin Superseal		0,50 m	
36-3810-004	1/-	LED	12V 24V			3 pol. ASS3 3 pin ASS3		0,50 m	
36-3864-004	1/-	LED	12V 24V		für Einzelbau for single mounting	P&R		0,50 m	
36-3864-014	1/-	LED	12V 24V		für Einzelbau for single mounting	P&R		2,00 m	
36-3867-014	1/-	LED	12V 24V		für Einzelbau for single mounting	2 pol. ASS2 2 pin ASS2		0,50 m	
36-3867-024	1/-	LED	12V 24V		für Einzelbau for single mounting	2 pol. ASS2 2 pin ASS2		2,00 m	
36-3865-004	1/-	LED	12V 24V		für Einzelbau for single mounting	3 pol. ASS3 3 pin ASS3		0,50 m	
36-3867-004	1/-	LED	12V 24V		für Einzelbau for single mounting	2 pol. Superseal 2 pin Superseal		0,50 m	

A.PIERINGER GmbH

www.ap.works

2141 Ameis, Obere Hauptstraße 68

Telefon: +43 / 2425 / 278 00

E-Mail: vk@ap.co.at



REGPOINT II LED

ZUBEHÖR / ACCESSORIES

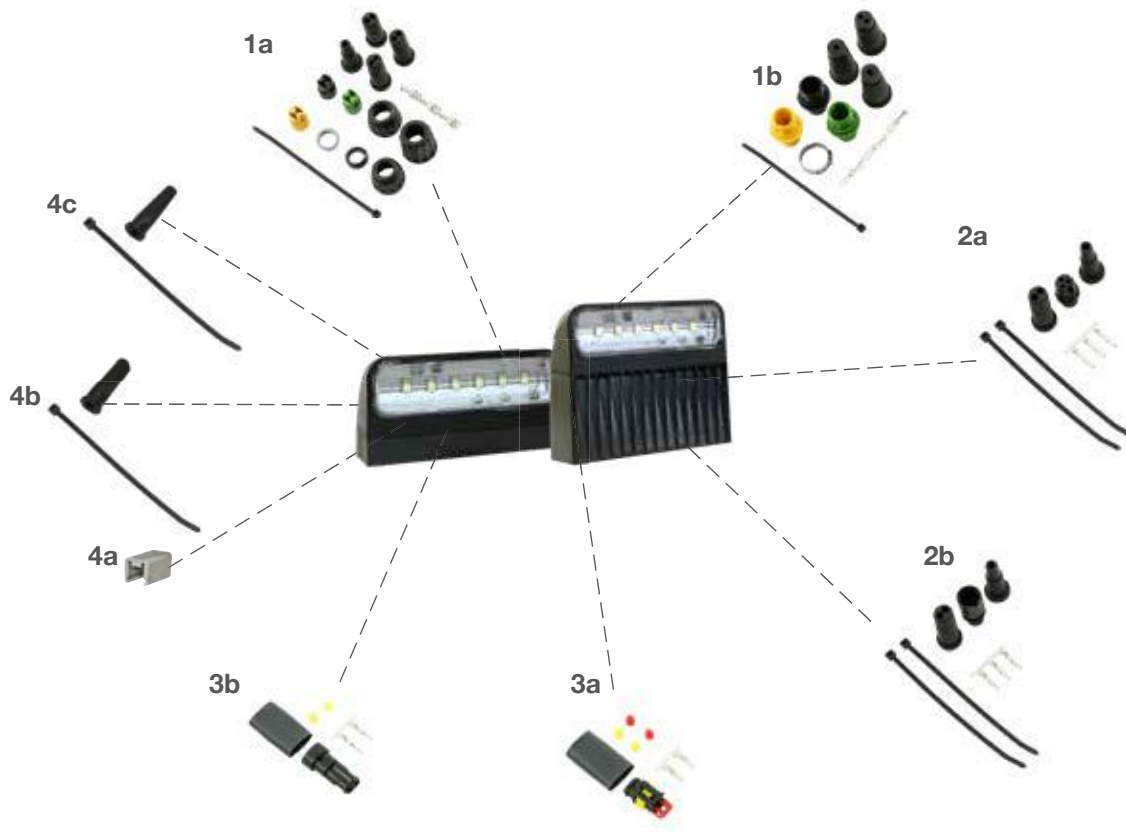

- 1 ASS1 & ASS2 Verbinder | ASS1 & ASS2 connector**
- (a) 2 pol. weiblich
2 pin female 13-5626-401
 - (b) 2 pol. männlich
2 pin male 13-5625-991
- 2 ASS3 Verbinder | ASS3 connector**
- (a) 3 pol. weiblich
3 pin female 13-0322-281
 - (b) 3 pol. männlich
3 pin male 13-0332-281
- 3 Superseal Verbinder | Superseal connector**
- (a) 2 pol. weiblich
2 pin female 15-7002-044
 - (b) 2 pol. männlich
2 pin male 15-7002-054

- 4 für P&R Verbinder | for P&R connector**
- (a) Verschlusskappen
caps 15-5971-014
 - (b) Endkappen rund
end caps round 15-5983-024
 - (c) Endkappen eckig
end caps square 15-5729-014